

Survey and Test Excavation of the Huanbei Shang City in Anyang

Anyang Work Team of the Institute of Archaeology, CASS

Keywords: Henan Anyang Huanbei Shang city-site Middle Shang period

I. Introduction

The Huanbei Shang city-site 洹北商城 (hereafter abbreviated as the Huanbei site), dated to the Middle Shang period, was discovered in 1999. It is the largest walled Shang city in current archaeological map (Tang *et al.* 2000). The Huanbei site is located north of the Huan River 洹河 in the northern suburb of modern city Anyang 安阳, Henan. About 19 km to the west is the eastern foothill of Taihang Mountains 太行山, to the north the low-relief hill, and to the east and south the broad alluvial floodplain. The general topography of the site is relatively flat, slightly higher in elevation in the northwest than in the southeast. This walled urban site situates immediately northeast of the limit of YinXu 殷墟, the well-known capital site of Late Shang period, with a slight overlapping (Fig. 1).

For the need of systematic investigation of the Huanbei site, the walled area is first divided into nine “Work Zones” of equal size, labeled as I, II, III, ..., IX from west to east and north to south. Each working zone is then subdivided into four quadrants, numbered as I-1, I-2, I-3, I-4, II-1, II-2, ..., IX-1, IX-2, IX-3, IX-4 (Fig. 2).

This article presents a preliminary report on the brief history of the investigation of the Huanbei site, some issues on survey method and strategy, as well as some major results from intensive subsurface survey and test excavations from 1999 to 2001.

II. History of the Investigations and Survey

Method

As early as in 1960, it was the first time to find some artifacts, dated to the Middle Shang period, within the limit of the walled Huanbei site identified later¹. These finds were located by the Anyang Work Team of the Institute of Archaeology at the Chinese Academy of

Sciences (now the Anyang Work Station of the Institute of Archaeology at the Chinese Academy of Social Sciences) in the vicinity northeast of the village Huayuanzhuang 花园庄 north of the Huan River (Zhongguo 1983) (see Locus 1 in Fig. 2). Eight bronze vessels, including *ding*-tripod 鼎, *yan*-steamer 甗, *jia*-tripod 斝, *et al.*, were accidentally found in a cache by local farmers about 300 m southeast of the village Sanjiazhuang 三家庄 in 1964 (see Locus 2 in Fig. 2); at the same time, one *jue*-cup 爵 and one *ge*-halberd 戈 were also collected (Meng 1985). In 1979, staff at the Anyang Museum collected one bronze *ding*, one bronze arrowhead, one bone arrowhead, and a few pieces of perforated shell objects in the village Dongwangdu 董王度 (Meng 1991) (see Locus 3 in Fig. 2). In 1980, the Anyang Work Station of the Institute of Archaeology at the Chinese Academy of Social Sciences excavated eight tombs at the construction site of the Anyang Youth Textile Plant about 100 m north of the village Huayuanzhuang (see Locus 4 in Fig. 2). From these eight tombs are found a number of bronzes and ceramics. Based on our current understanding of the Huanbei site, the materials revealed from the 1960s through 1980s are all located within the limit of the walled city of Middle Shang. In addition, excavations were conducted from 1997 to 1999 near Huayuanzhuang in order to obtain ¹⁴C samples for the Xia–Shang–Zhou Chronology Project (see Locus 5 and Locus 6 in Fig. 2). The excavation to the west of the village covers 136 sq m (Zhongguo 1998a), and that to the east more than 1000 sq m (Zhongguo 2004).

The major advance toward the discovery of the Shang city site at Huanbei was not made until 1997 when the work of systematic regional archaeological survey along the Huan River was initiated and undertaken jointly by the Institute of Archaeology at the Chinese Academy of Social Sciences and the University of

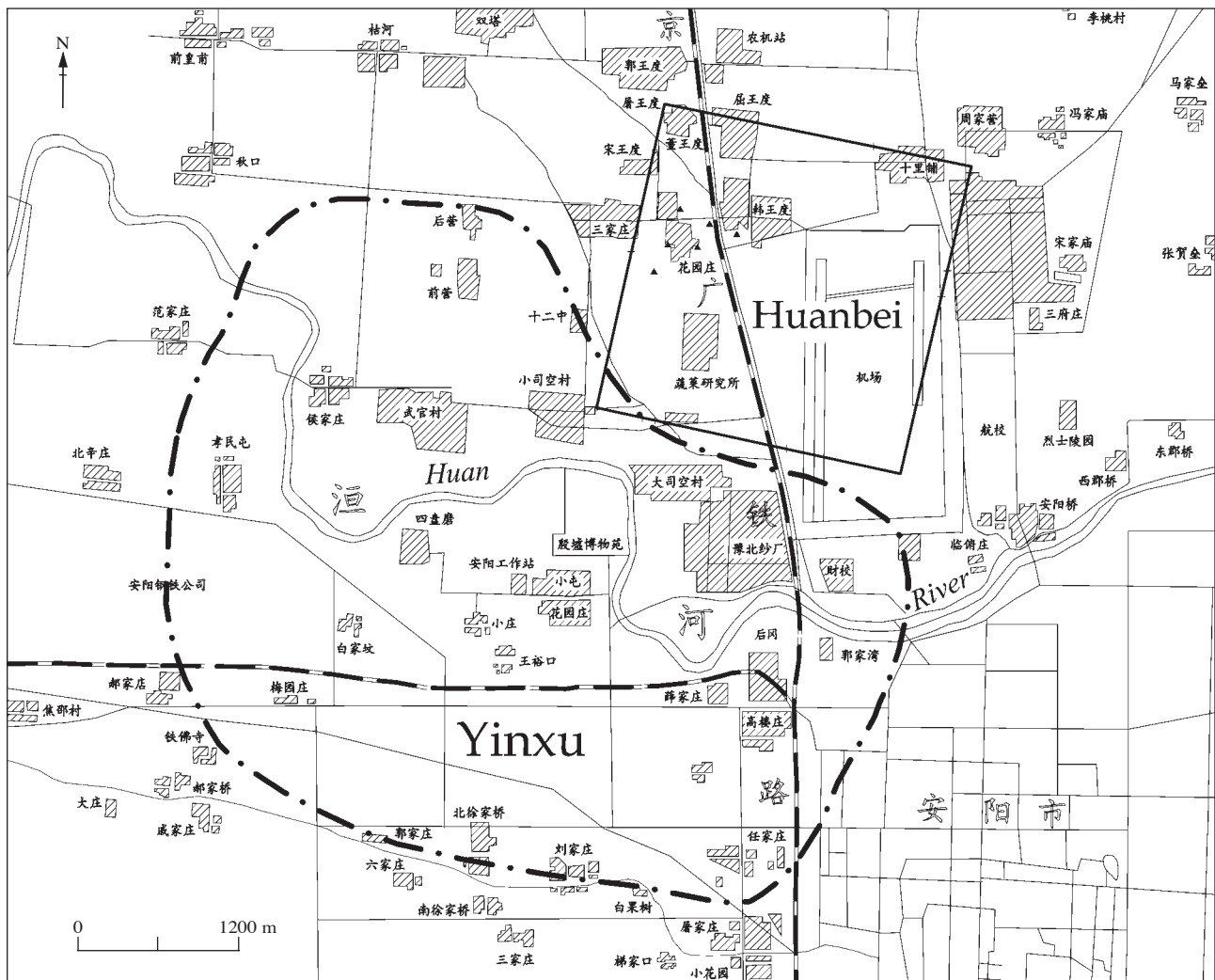

Fig. 1 The location of the Huanbei Shang City in relation to Yinxu

Minnesota. This joint effort aimed to investigate long-term history of man-environmental interactions, and cultural transformations as well as the history of the socio-political development from village societies to early state societies. A two-stage survey strategy was adopted in our regional survey of the Huan River valley. The first step involved an extensive field-walking survey with the objective of collecting coarse-grained information of all investigated sites in the project area. The second step was an intensive surface/subsurface survey targeted at specific sites identified during the extensive survey, aiming at furnishing detailed information on site size and shape, intra-site spatial variation in artifact density on the surface, and in cultural deposits beneath the surface, chronological periods during which a site was in use, and its functional categories, which are all fundamental to the study of settlement systems.

After a preliminary analysis of the sites investigated

during our initial extensive survey, four sites/localities were first selected for intensive survey (Zhongguo 1998b)². The area in the vicinity of Huayuanzhuang was targeted as the first locality for intensive survey on the basis of the following considerations:

1. At the very onset of the collaborative project, a great attention was paid specifically to the investigation of the Middle Shang settlement pattern because it would provide critical data on the emergence of last Shang capital at Yinxu (Tang 1999).

2. The scattered Shang remains of pre-Yinxu found from the 1960s through 1980s seemed to have concentrated in an area near Huayuanzhuang north of the Huan River. Furthermore, the contemporaneity and spatial relatedness of these finds suggested that they might have come from different parts of the same settlement site³.

3. Our geoarchaeological survey revealed the existence of two different types of paleosols⁴ across the area

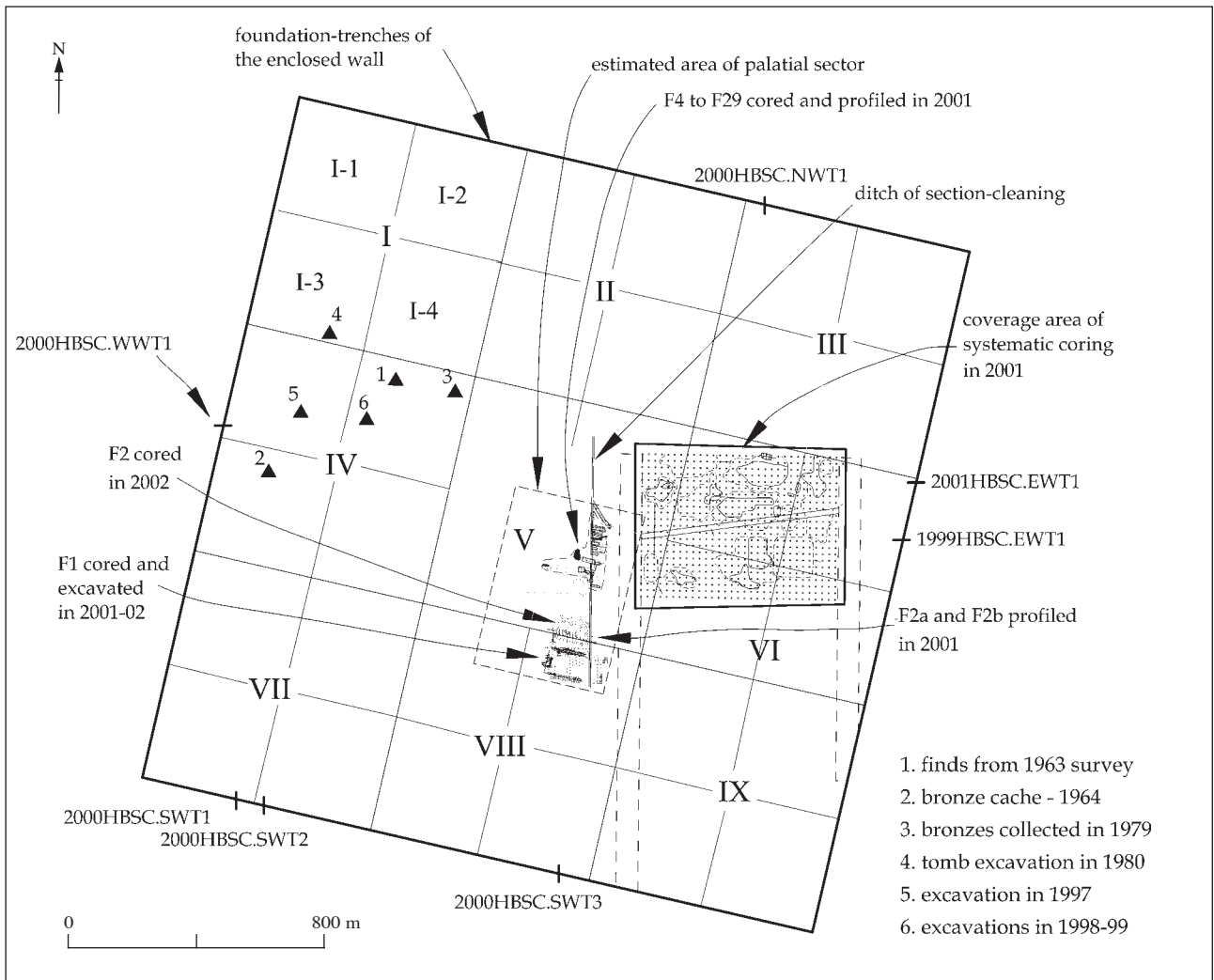

Fig. 2 Map of work zones showing the localities of excavation and survey at the Huanbei site

from Huayuanzhuang in the west to Hanwangdu 韩王度 in the east. These two paleosols have direct relevance to cultural remains of Shang and other early periods. To the west of Huayuanzhuang, the Shang and other early sites always directly rest on or associated with a strong brown paleosol developed from aeolian deposit. To the east of Hanwangdu and its nearby was a different type of paleosol that was derived from alluvial sediments. The identification of this alluvial paleosol was also one of the factors leading us to conduct an intensive subsurface survey in the area so that we were able to determine the potential of buried cultural remains that might be associated with the different physical setting as represented by alluvial paleosol⁵.

4. A walkover survey was carried out over a broad area near Sanjiazhuang 三家庄, Huayuanzhuang, and other nearby villages. Except a very few scattered ceramic shards found in the fields south and east of Hua-

uanzhuang, almost no remain of Shang or other early periods was found on the ground. We were left no choice but intensive subsurface survey by employing Luoyang 洛阳 spade if we needed to evaluate the distribution and nature of cultural remains in the area where scattered finds of Middle Shang were located in the previous years⁶.

In the spring of 1998 the joint project “Regional Archaeological Survey of the Huan River Valley” began intensive subsurface coring in an area of approximately 1,300 EW×1,200 NS sq m centered in the village of Huayuanzhuang. Over two hundred cores with intervals of 10–20 m were drilled along one E-W line and one N-S line, finding a contiguous cultural deposit that would tie together all the scattered finds from the 1960s through 1980s. And it concluded that the Shang site at Huayuanzhuang and its nearby had its total area “no less than 150 hectares (Zhongguo 1998b). Moreover, a large num-

ber of pounded earth foundations were detected in a large portion of the area east of Huayuanzhuang. The discovery of such a large region containing the remains of Middle Shang strongly suggested the importance of the surveyed area for the determination of settlement patterns of this poorly understood period⁷.

In the fall of 1999 we continued subsurface coring beyond the area investigated during the previous season. We all felt strongly the need to continue our intensive survey for a better understanding of the buried settlement because many basic features of the site remained unclear, such as its spatial relation with Yinxu, site boundaries, the presence of residential and public buildings, the continuity and duration of buried cultural deposits, as well as its stratigraphic and geomorphologic setting.

Like in the previous seasons, the survey in 1999 kept surprising us with unanticipated results. We started to drill from all four directions toward the outside of the area with buried cultural deposits delimited in the previous season. Given the size of the buried site, an interval of 50 m was used when there was no change observed in stratigraphy of both geology and archaeology. But whenever a change was noticed with regard to stratigraphies, the interval would be adjusted accordingly as small as 5 m. About 250 cores were drilled during our twenty days of intensive survey. It turned out that the buried site was much bigger than had been estimated in the previous season, and our conservative estimation at that time was about 300 hectares in area. By the end of October 1999, the site boundaries except the east one had been very much determined. This astounding development encouraged Chinese members of the project to continue the coring work in the following two months.

In an attempt to determine the east boundary of the site as well as to search for large foundations of pounded earth within the site, the coring team was surprised by another unanticipated development as the wall built of pounded earth was finally detected near the east runway of the Anyang airport in the beginning of November. The detection of the pounded earth wall marked another turning point in our intensive survey of the large buried site north of the Huan River because the presence of pounded earth wall and the massive size of the site would assure a political status of central urban settlement during the Middle Shang period. After the pounded earth wall came to see the light, the coring team was largely expanded to trace the walls enclosing the urban settlement. In order to trace the buried remnants of pounded earth wall, a new coring strategy was adopted. Coring transects

with intervals of 10–20 m were laid out to cross the potential extending course of buried pounded earth wall foundations, and cores were drilled at intervals of 2 m along each transect. All four sides of the city wall were then traced out in the following month (see Fig. 1), and a test excavation was also carried out by opening a trench (1999HBSC.EWT1) across the east wall in order to examine the structure and composition of the city wall. This walled urban site was then named the Huanbei Shang City (Huanbei literally means “north of the Huan River”).

Following the discovery and survey of the Huanbei site in previous seasons, our archaeological investigation focused on intensive subsurface survey of this newly found urban settlement through systematic coring during the field campaigns of 2000 and 2001. The immediate field objective of intensive survey at the site was to define as precisely as possible site boundaries, duration of the settlement, and layout of the city plan such as the presence and location of small-scale residential and large public buildings. We had our research focus on the intensive subsurface survey of the Huanbei site not on the basis of its size or potential for “important” material finds but a necessary means to help address when, how, and why the pre-state societies were transformed into state-level societies in the region, and explore the impacts on the regional landscape of the establishment of this possibly first urban center in the Huan River valley. Cities, particularly capital cities, played a crucial role in the origin and operation of early states because they were the foci of central political, religious, and economic institutions (Blanton 1976; Chang 1976; Wheatley 1971). Examination of the walled Huanbei site through intensive survey and selective excavation should contribute to a better understanding of urban processes and state formation on both local and regional levels. In addition, we expected that this buried urban site would offer us a testing ground to evaluate the utility and necessity of intensive coring as an appropriate approach for a regional survey in the area like the Huan River valley with substantial sedimentation to accurately reconstruct the past human settlement systems.

Geological and archaeological coring was carried out in the fall of 2000, aiming at (1) detecting the distribution of cultural deposits immediately outside of the walled area in order to determine as precisely as possible site boundaries; (2) mapping the buried paleosols, particularly in the immediate area outside of the walled area; and (3) determining the geomorphic setting of the

site, especially the possible existence of old river courses. Over 200 cores were drilled along the east-west and north-south lines across and beyond the walled area, covering an area of 2500 m east-west by 2300 m north-south. Buried cultural deposits of Shang period were found beyond each wall of this site, particularly in the neighboring area outside the west wall, which was important for better understanding how the communities of this urban settlement were organized and structured.

During the field campaign of 2000, trial excavations were also carried out by the Anyang Work Station at the Institute of Archaeology, CASS, to open five additional trenches across different parts of the wall for further studying the structure of pounded earth city walls (see Fig. 1)⁸.

The field campaign of 2001 was from the middle of August through the middle of October, and its focus was on systematic coring of the walled area to determine the layout of the city plan such as the presence and location of small-scale residential and large public buildings. The systemic coring was first launched in an area of 650 × 480 sq m (31.2 hectares) between two runways at the north end of the airport field in Work Zone VI and east edge of Work Zone V (see Fig. 2). A coring team of 12 people, nine drilling holes and three taking notes, carried out systematic drilling with a block of 3 × 3 rows at intervals of 20 m each time. Whenever a change was noticed with regard to stratigraphies, the interval would be adjusted accordingly as small as less than 1 m, in order to determine the nature, size, and shape of cultural features, particularly burials, house foundations, and roads. Each hole was drilled down to the paleosol⁹, around 2.0–3.0 m, on which the cultural remains at the Huanbei site were situated. The coring profiles were examined for not only its cultural contents but also the soil stratigraphic context of the cultural deposits, which would enable us to reconstruct the paleogeography during site occupation and to determine processes of site formation, abandonment, and preservation. Over 1000 holes were drilled in this area; and many types of cultural deposits were identified.

Following systematic coring in Work Zone VI, we moved to an area covering the northeast portion of Work Zone VIII and the east portion of Work Zone V (see Fig. 2) in the beginning of September 2001. There were a number of reasons for conducting detailed site survey here. First of all, our systematic site survey intended to map all open fields accessible for intensive coring in order to determine the distribution of buried cultural remains, then to understand spatial settlement patterns, particularly the hierarchy of settlement organization as

well as the planning and usage of domestic and public space. Since the central part of the walled city was occupied most likely by elite groups of the society according to archaeological finds at many early cities in China and traditional texts, it was simply logical to plan a site survey as detailed as possible in all open fields along the central north-south axis of the walled city, specifically Work Zones II, V, and VIII. Secondly, the selection of this area for a detailed site survey had its practical reason during this particular season of the year. Corn crops grew very tall and dense in almost all the agricultural fields in September, which made impossible for any form of systematic site survey, either surface walkover or subsurface drilling. The area west of the airport field in the central part of the city site is an apple orchard in which growing crops, mostly vegetables, were relatively sparse and short, thus allowing us to drill in accessible fields, at least at coring intervals acceptable for evaluating cultural remains beneath modern ground¹⁰.

We began to drill from the south end of the area, at intervals of 10 or 20 m, mainly along the small paths, mostly east-west oriented, inside the apple orchard to the west of the airport field. After a couple of days, first samples of pounded earth were recovered from cores placed on the north-south path on the west edge of the airport protection ditch¹¹, near the south end of the apple orchard. Coring intervals were then adjusted to trace the features that samples of pounded earth might represent. After drilling more than two hundred and fifty holes, the traced feature turned out a rectangular enclosure (labeled as 2001HBSCF1 during later excavation), measured about 174 m east-west by 90 m north-south, generally made of about 70–150 cm of hard pounded earth covered with deposits containing reddish burned earth fragments.

The rectangular enclosure crosses the airport protection ditch at its east end. This ditch serves the west edge of the airport field, and it is about 4 m wide and 2 m deep, with a drained bottom. Given the fact that the sterile soil holding Shang remains is buried at the depth of about 2 m here, this ditch is certainly well suitable for section cleaning to examine vertical profiles of those cultural features that are cut by the ditch. After delimiting the extension of this rectangular enclosure on all four sides, section cleaning was immediately carried out on the east bank of the ditch to study the composition and structure of this rectangular architectural remain.

After the detection of the rectangular enclosure at the south end of the apple orchard, we continued our intensive drilling northward in open fields on both sides of the

airport protection ditch. Meantime, we paid a great attention to possible outcrops of building remains that might be cut by this north-south ditch. Pounded earth continued being found in the drilling holes, and more pounded earth profiles of building remains were seen in the ditch after a very preliminary and quick cleaning. Given high concentration of pounded earth building remains in this surveyed area, we decided to conduct a full scale of section cleaning on both sides of the ditch from its south end running about 606 m toward the north¹². Along this long section in the ditch, 25 individual buildings were located, numbered F1, F2, ..., F24, and F25 from south to north¹³. In addition, 11 refuse pits were found on the section profile, labeled H1, H2, ... H10, and H11 from south to north. Stratigraphic profiles were examined and drawn at a full scale over the total length of this ditch section in order to detail the stratigraphic and chronological relationships of these building remains. The ground plan of each building remain was traced by drilling in the fields both east and west of the ditch.

Anyang Work Station at the Institute of Archaeology, CASS began an excavation of the rectangular enclosure (F1) in the October of 2001, and the first season of this excavation lasted until the end of December of 2001. The excavation resumed in the April of 2002 and continued until the August of 2002. About 8,000 sq m were opened during two seasons of excavation, covering two thirds of the whole rectangular enclosure¹⁴ (Zhongguo 2003).

During the June of 2002, intensive coring was conducted to investigate potential architectural features in the area immediately north of F1. Another rectangular enclosure (F2) was detected only 27 m north of F1. It has a similar structure but its size is smaller, about 90 m wide and 70 m deep (see Fig. 2).

III. Enclosed Walls and Their Foundation-trenches

Based on our current survey data from intensive coring, the walled area of the Huanbei site is approximately square, measuring about 470 hectares, 2,150 m east-west by 2,200 m north-south¹⁵ (see Figs. 1 and 2). The enclosed wall is oriented about 13 degrees northeast, characteristic of many architectural buildings of Shang culture such as city walls, palace-temples, residential houses, and tombs of different sizes (Yang 1989; Zhu 2003).

In order to examine the structure and date of the

enclosed walls, seven excavation trenches were dug across the wall line at all four sides, including two on east (1999HBSC.EWT1 and 2001HBSC.EWT1), one on north (2000HBSC.NWT1), one on west (2000HBSC.WWT1), and three on south (2000HBSC.SWT1, 2000HBSC.SWT2, and 2000HBSC.SWT3) (see Fig. 2).

Intensive coring and trenching disclose that most parts of the wall do not survive except its footings. The foundation-trenches are mostly 7 to 11 m wide at their opening with a depth of about 4 m. The foundation-trench of south wall is filled only with poorly pounded earth or simply not-pounded soil, different from east, west, and north sections of the city wall where well pounded earth with clear pounding layers and impressions were found. The east wall is raised to about 0.3 m above the original ground level (the opening of foundation-trench), while north and west walls are leveled with the original ground. In all four trial trenches across north, east, and west walls, excavation stratigraphies show deposit of dual foundation-trenches: inner foundation-trench deposit superimposed by outer one. In other words, the deposit filled in the foundation-trench formed in two steps: the earth fill of about 1.5 m wide was first laid down without tamping on the inner side of the city; then a different type of earth (dark gray silt clay¹⁶) was used to fill the trench. The outer foundation-trench deposit is usually composed of layers, mostly 10–15 cm thick, of pounded earth. The pounding impression in the deposit suggests that it might be pounded by means of small-wooden pestles that were bundled together.

Trenches across east and west walls show that the deposit of foundation-trenches is superimposed stratigraphically by the levels of Shang period. The foundation-trench in the east wall cuts through a Longshan 龙山 level. The foundation-trench deposit contains two categories of artifacts. The first category is remains associated with the sacrificial activities that might have occurred during the construction of foundation-trenches, as seen in the outer foundation-trenches of the west wall, including concentrations of relatively complete dog skeletons and pig skulls¹⁷. The second category is pottery shards most of which are of Middle Shang, some of Longshan. No ceramic shard is dated later than the Phase I of YinXu period. All these strongly suggest that the wall foundations were constructed during the Middle Shang period. Neither coring nor trenching indicates the existence of moats outside the foundation-trenches.

What is revealed from the examination of trench profiles strongly suggests that the construction of the

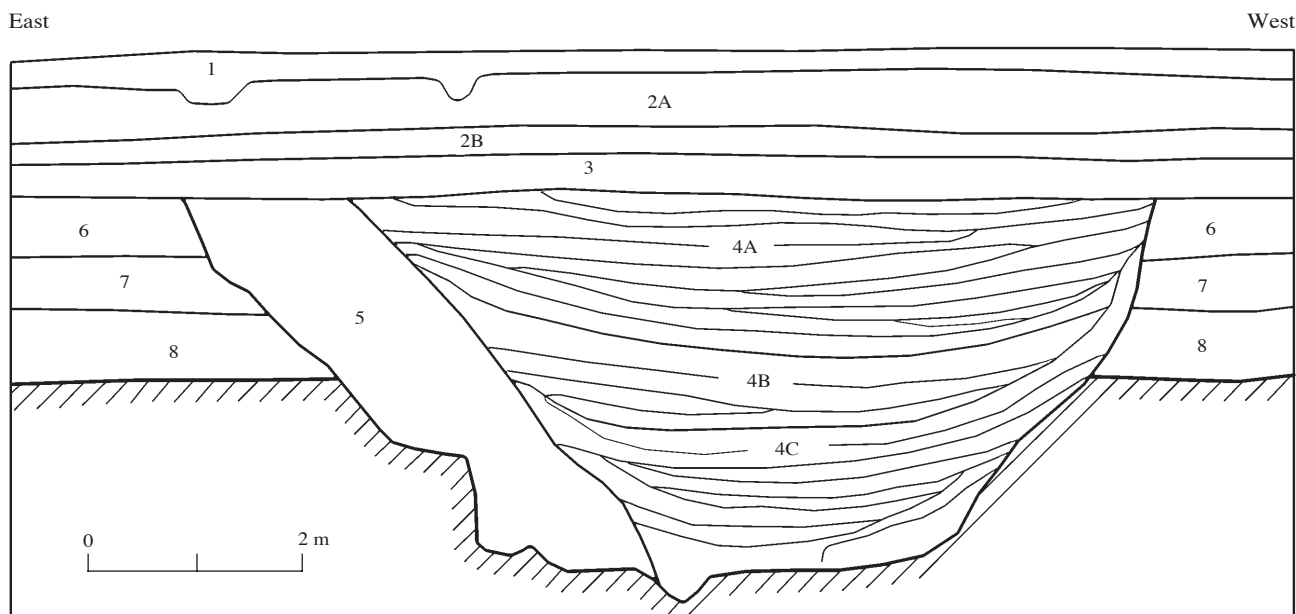

Fig. 3 Profile of Trench 2000HBSC.WWT1 across the west wall of the Huanbei site

city wall might not have been completed before this urban settlement was abandoned. It is traditionally believed that the city wall was usually built later than initial civic and residential buildings. The fact that continuous cultural deposits, as disclosed by intensive coring in 2000, were not limited to the walled area also seems to support this argument.

Here only two trenches (2000HBSC.WWT1 and 2000HBSC.NWT1) are selected to illustrate the structure and nature of foundation-trenches of the wall at the site.

1. Trench 2000HBSC.WWT1 (in the middle of west wall)

Trench 2000HBSC.WWT1 is located in the middle of the west wall, about 1,050 m from northwest corner of the walled area (see Fig. 2). This trench, 20 m long east-west by 5 m wide north-south, was laid down aligning with true east-west. The south profile of the trench shows eight stratigraphically distinguishable units (stratigraphic levels). From top to bottom, these are (Fig. 3):

1: modern plowed or disturbed top soil, about 0.18–0.35 m thick.

2: brownish yellow soil, composed of two sublevels.

2A: more yellowish and more friable soil, 0.54–0.68 m; many artifacts of late historic periods, including white and blue porcelain fragments, and three copper coins of “*yuan feng tong bao* 元丰通宝” dated to AD 1078–1085 (Yuanfeng reign period of the Northern Song Dynasty); two wells of the Northern Song Dynasty with

their openings in this substratum.

2B: brownish yellow and less friable soil, 0.15–0.3 m thick, 0.76–0.86 m in depth; contained artifacts similar to those in sublevel 2A.

3: yellowish brown soil, relatively friable, 0.16–0.32 m thick, 1–1.1 m deep; containing Shang ceramic shards, animal bones; overlying the top of foundation-trench deposits.

4: deposit of outer foundation-trench, dark gray soil, composed of 23 pounded layers that are bowl-shaped, and rise from the center to both edges; each of pounded layers about 0.1–0.3 m thick; subdivided into three sublevels.

4A: including eleven layers some of which were well pounded while others were less pounded; containing ceramic shards of the Middle Shang (Fig. 4) and animal bone fragments (Fig. 5); one bored scapular with burn marks but no inscription (Fig. 6).

4B: composed of four well-pounded layers with clear stratification; a few ceramic shards of the Middle Shang and animal bone fragments.

4C: consisting of eight layers of which the lower ones are reddish brown, not pounded, and relatively moist; a large number of the Middle Shang ceramic shards and animal bones some of which are dog skulls and cervical bones.

5: deposit of inner foundation-trench, yellowish brown, relatively soft, and not pounded; containing Shang ceramic shards and animal bones; one fragment of

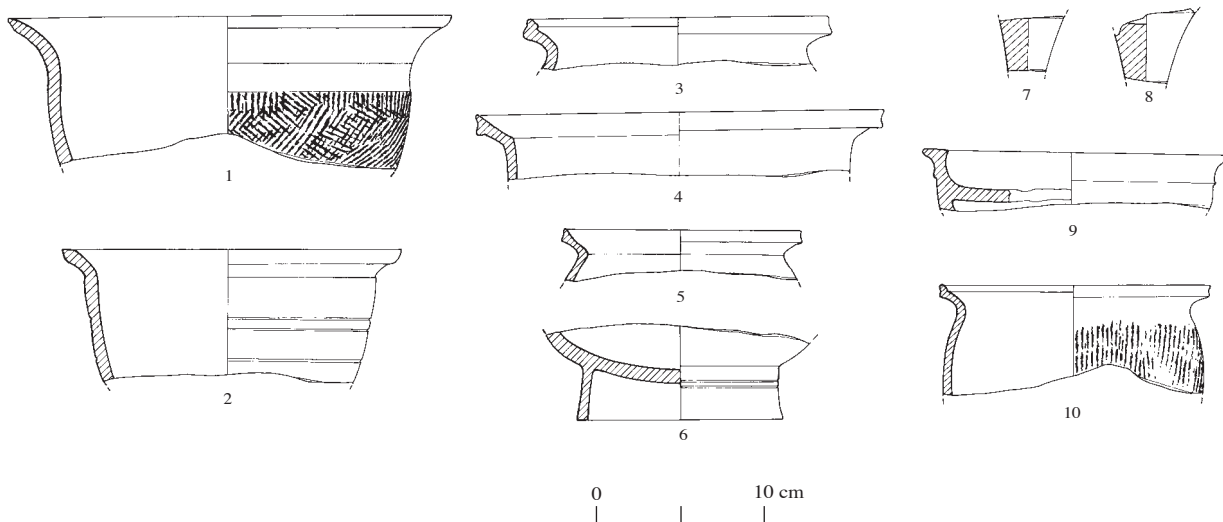

Fig. 4 Pottery samples unearthed from outer foundation-trench deposit of the west wall of the Huanbei site

1, 2, 4. bowls with a deep belly (WWT1JA:3, 2, 7) 3, 5, 10. *li*-tripods (WWT1JA:8, 4, 6) 6. *gui*-vessel with a ring foot (WWT1JA:10) 7, 8. *li*-tripod's feet (WWT1JA:5, 1) 9. *dou*-pedestal serving-stand

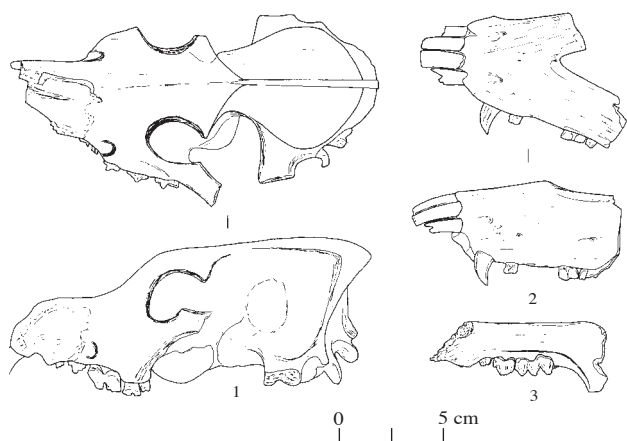

Fig. 5 Animal bones unearthed from outer foundation-trench deposit of the west wall of the Huanbei site

1. WWT1JA:12 2. WWT1JA:14 3. WWT1JA:13

oracle bovid scapular, bored but not chiseled, with burn marks but no inscription¹⁸.

6: yellowish brown soil, relatively homogeneous, slightly firm; 0.5–0.6 m thick, 1.25–1.55 m deep; containing no ceramic shard.

7: yellowish soil, more friable than the level 4; 0.32–0.5 m thick, 1.85–1.95 m deep; containing only two small pieces of ceramic shards.

8: dark brownish soil, slightly firm; 0.6–0.75 m thick, 2.25–2.4 m deep; containing no pottery shard or other artifacts but small fragments of pounded earth on the bottom.

Beneath level 8 is reddish brown sterile soil (clayey

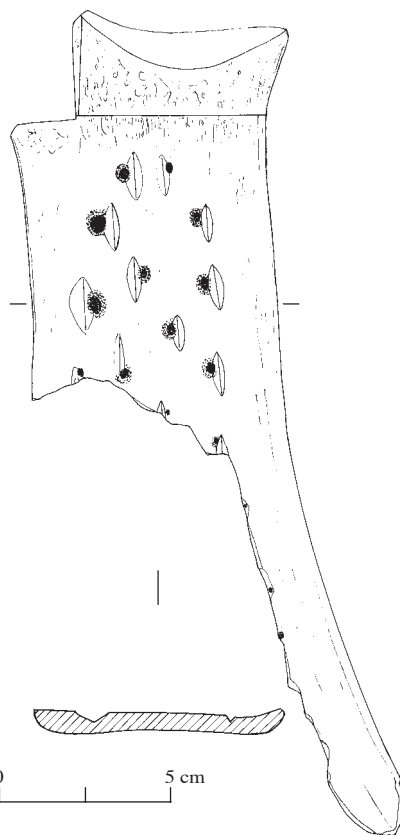

Fig. 6 Bored scapular unearthed from outer foundation-trench deposit of the west wall of the Huanbei site

silt and loamy clay), underlain by a layer of light brownish yellow or yellowish silt clay containing abundant calcium carbonate nodules, showing the same stratigraphy as in other parts of the area near the west wall.

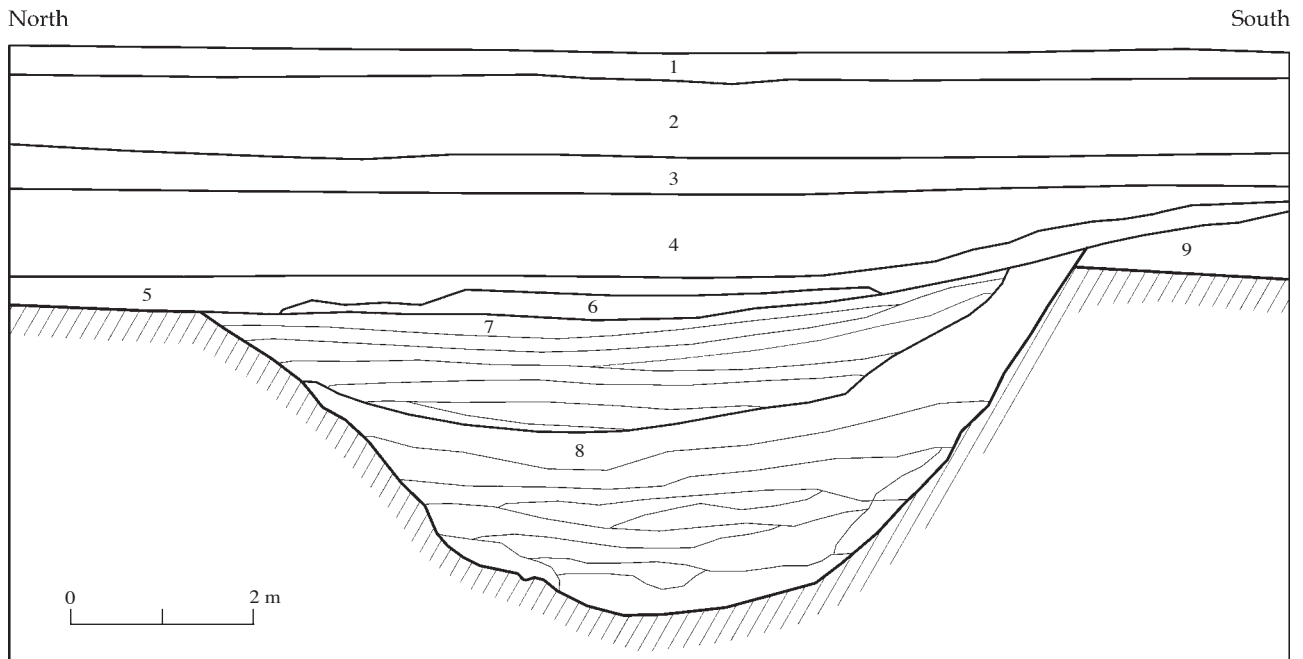

Fig. 7 Profile of Trench 2000HBSC.NWT1 across the north wall of the Huanbei site

Based on unearthed artifacts and stratigraphic relations, level 2 is of the Northern Song Dynasty, and level 3 is of the Middle Shang period. The dates for levels 6–8 cannot be determined due to the lack of identifiable artifacts.

The foundation-trench deposit (levels 4A, 4B, and 4C) is superimposed by level 3, and its top surface is about 9–9.5 m wide, and 1.05–1.25 m below the modern ground. No wall remain is found above the foundation-trench. The deposit in the foundation-trench is composed of inner and outer portions (i.e. so-called dual foundation-trenches). The interface between inner and outer trench deposits is about 1.55 m from the east edge of the foundation-trench.

2. Trench 2000HBSC.NWT1 (in the middle of north wall)

Trench 2000HBSC.NWT1, 15 m long north-south by 4 m wide east-west, was dug into the middle section of north wall, about 700 m from the northeast corner of the walled enclosure (see Fig. 2). It was laid down along the direction of true north-south. On the east profile of this trench are nine distinguishable stratigraphic levels from top to bottom as follows (Fig. 7):

- 1: plowed or disturbed top soil, 0.3–0.4 m thick.
- 2: yellowish brown silt and clayey silt, 0.8 m thick, containing brick and white porcelain fragments that are dated to late historic period.
- 3: dark brown silt clay, 0.4 m thick.

4: yellowish loam or silt loam, 0.8–1 m thick, containing no artifact.

5: dark brown silt clay, 0.2–0.3 m thick, containing a few ceramic shards of the Middle Shang, the opening of the foundation-trench beneath this deposit.

6: wall deposit above the foundation trench, dark brown silty clay and clay, 0.05–0.25 m thick, pounded, but slightly friable possible due to weathering.

7: deposit of outer foundation-trench, dark brown soil, about 9 m wide at its top, 1.3 m thick, composed of eight pounded layers ranging from 0.15–0.25 m in thickness.

8: deposit of inner foundation trench, 9.8 m wide at the top, 3.4 m thick (along the middle line), shaped like a shallow bowl, soft, and possibly slightly pounded, composed of 9 or 10 pounded layers ranging from 0.1 to 0.5 m in thickness.

9: brownish soil, no artifact, cut by inner foundation-trench.

Beneath level 9 is dark brown or dark gray silt clay and clay (A horizon of buried alluvial soil), sterile soil, underlain by brownish yellow carbonate nodule-enriched silt clay (B horizon of buried alluvial soil).

The foundation-trench (levels 7 and 8) cuts through level 9 and is overlain by level 5 that is dated to the Middle Shang. Inner and outer foundation-trench deposits are distinguishable, and the latter superimposes the former one. From both inner and outer foundation-trench

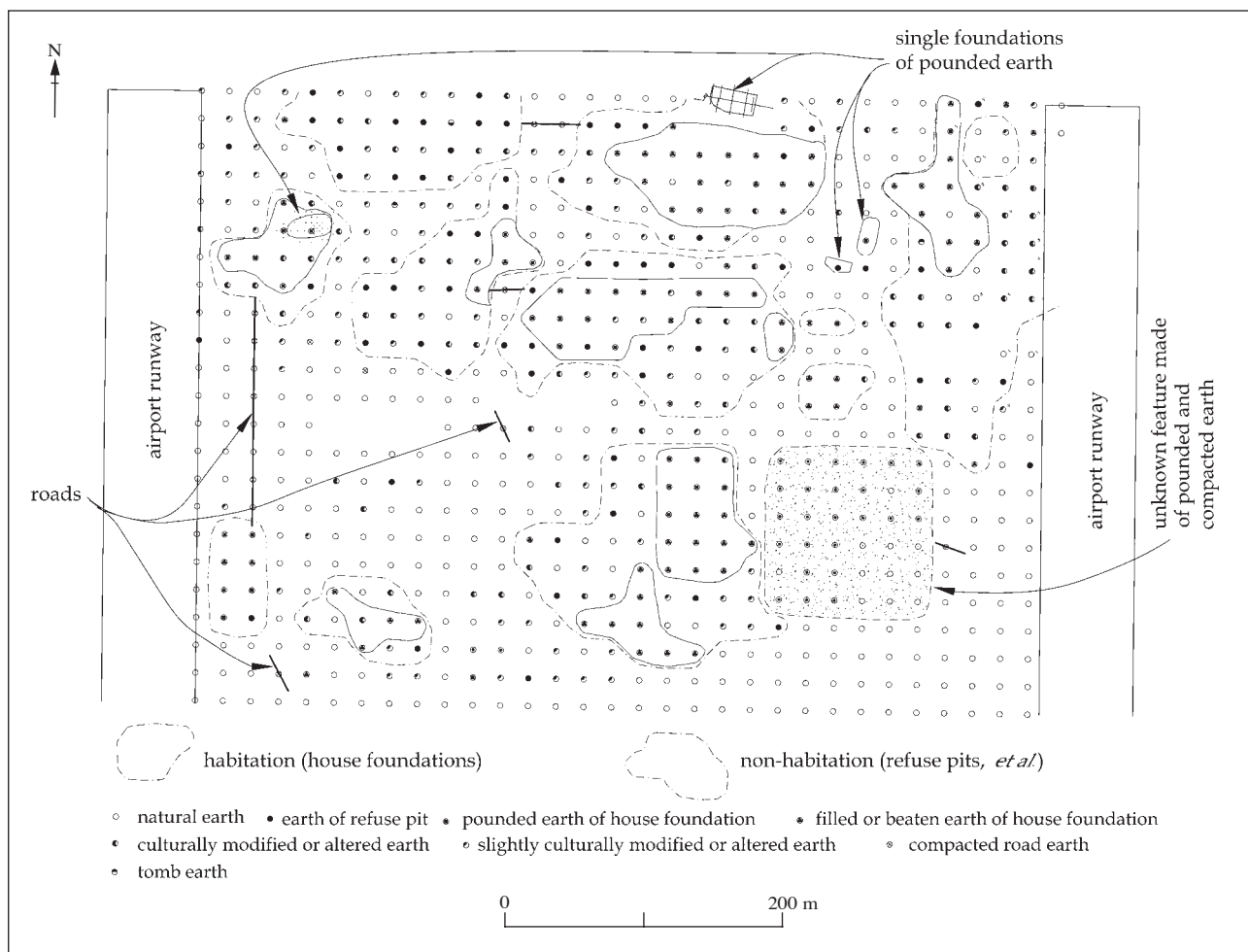

Fig. 8 Systematic site survey through intensive coring in Work Zone VI (Cores were drilled at intervals of 20 m. Additional cores at smaller intervals were drilled when features of interest were found. Most of these additional cores are not marked on the map)

deposits are a few fragments of pottery, animal bones, and burned earth.

IV. Settlement Patterns and Building Remains of the Walled Area

Despite a small coverage of systematic site survey through intensive coring in Work Zone VI and east edge of Work Zone V (see Fig. 2), it turned out highly productive and informative towards revealing intra-site variation and studying urban planning (Fig. 8).

First of all, the surveyed area has a high density of anthropogenic deposit mostly associated with habitation and living activities, and remains are generally buried at 1.5–2.5 m beneath the modern ground. These remains are primarily dated to the Middle Shang period according to diagnostic pottery shards from drilled holes. Habitation areas, dominated with cultural deposit of buildings, are usually surrounded by zones rich in refuse deposits, suggesting the formal disposal of refuse and waste. Each

habitation area is separated from another by zones with little or no cultural deposit. Roads, characterized by compacted and foliated dirty soils, were found between different habitation areas. Relatively large single buildings made of pounded earth were detected inside or outside habitation areas; among them are two single foundations found in the void formed by at least four habitation areas in the northeast portion of the surveyed area. These two single foundations, measured 28×12 m and 18×8 m respectively, might be of public buildings; such a space with non-domestic buildings in the middle might represent a plaza serving surrounding communities for public activities. All these strongly suggest that this surveyed area was a densely settled residential zone with an organized settlement system. A feature made of firm pounded earth detected in the southeast measures about 100×100 sq m; but its nature remains elusive because only a small number of holes were drilled¹⁹.

In contrast to Work Zone VI, Work Zones V and

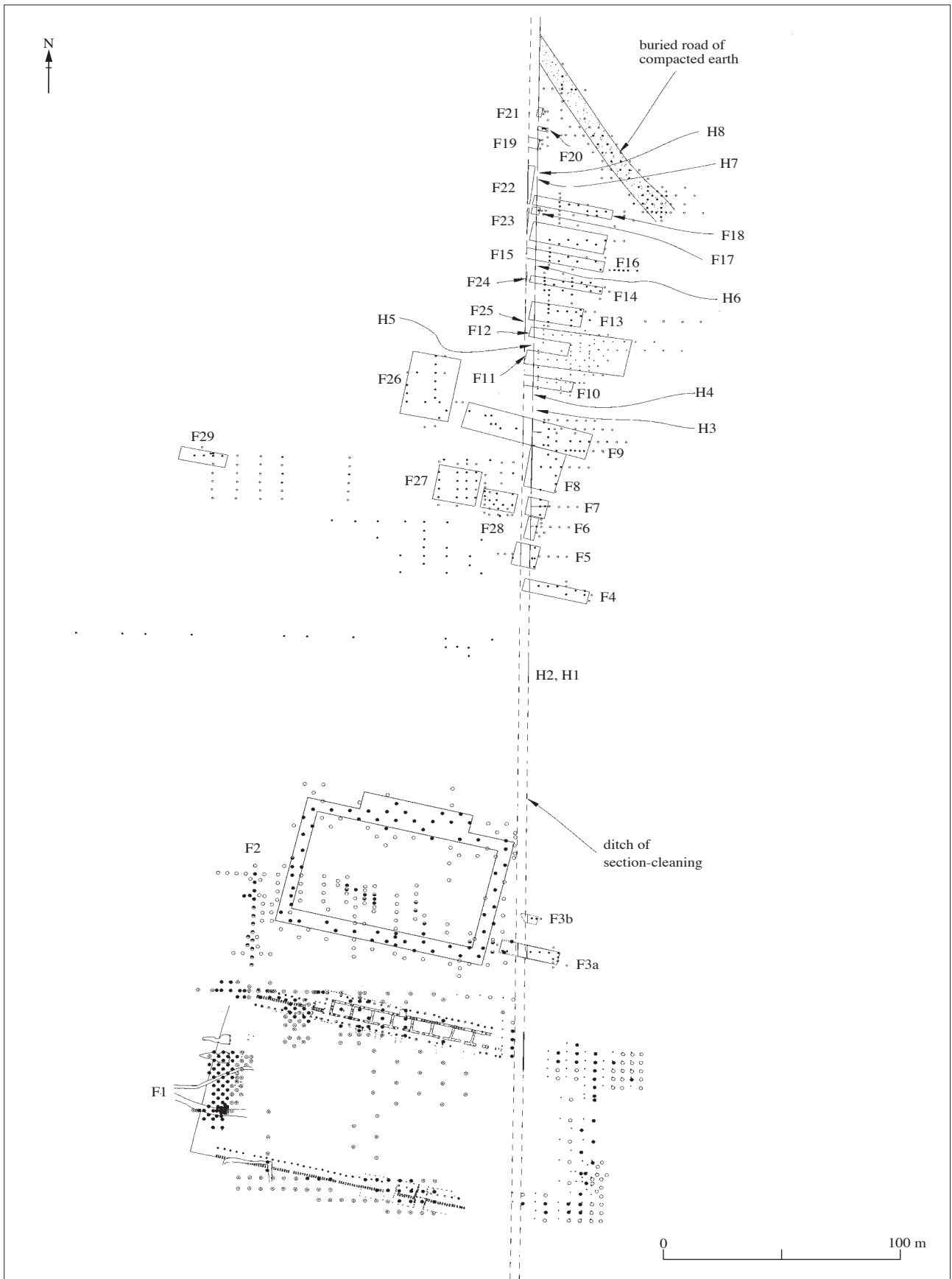

Fig. 9 The distribution of building remains along the section-cleaning ditch of 600 m long (Small dots are drilled cores using Luoyang spades)



Fig. 10 Photo of the building remain F13

VIII show a different type of settlement remains characterized by a concentration of platforms of building foundations made of hard pounded earth, including at least two large-size buildings with a courtyard (F1 and F2). Section-cleaning of a 600 m long ditch and intensive coring (not systematic) in a very limited area to the west of the ditch reveals at least 30 individual building foundations (Fig. 9)²⁰. There is one in Work Zone VIII-2 (F1), three in V-2 (F19–F21), and all others in V-4 (F2–F18, F22–F29).

These building remains are all made of hard pounded earth displaying an extremely high density and uniform material composition, quite different from those buildings found in other parts of the walled area such as Work Zones IV and VI where foundations are composed of less densely pounded earth with mixed source materials (Zhongguo 1998a; Zhongguo 2004). The foundation trenches of these buildings, usually in a shape of reversed trapezoid, are 0.4 m (F21) to 1.0 m (F3b and F24) deep, and their openings vary from 1.75 m (F20) to 15.8 m (F1) wide²¹. Postholes and associated stone plinths can be seen on the profiles of many buildings. The upper part of pounded earth remains above the foundation-trench is partially preserved building platform that ranges from 0.1 m (e.g. F12) to 0.9 m (F1) high. Usually the top part of platforms is severely weathered, leaving no trace of building platform surface in all building profiles except F13 (Fig. 10). The building remain F13 has a trench of 9.2 m wide and 0.5 m deep, filled with slightly- or not-pounded earth. Above the trench are layers of hard

pounded earth, 0.5 m high. The platform surface made of reddish burned plaster and white lime layers is well preserved simply because of overlying collapse deposit of reddish weathering-resistant burned earth. Collapse deposit of burned walls and roofs were found overlying most building remains, strongly suggesting that this cluster of buildings might have been destroyed by a fire that might essentially lead to the abandonment of the whole city²². Evidence of sacrifice can also be seen in association with the construction of buildings. An example is the sacrificial child burial situated beneath the stone base in a posthole exposed on the profile of F5. Child sacrifice was a common practice employed in architectural construction, particularly for those large public architectures.

This cluster of buildings as a whole are aligned about 13 degrees east of true north, consistent with city's overall orientation defined by city walls; but the central axis of each individual building is east-west in most cases (see Fig. 9), suggesting an orderly planning of building construction. While two largest single buildings are located at the south end, most building foundations are distributed densely in northern part of this long ditch section (Work Zone V-4, see Fig. 2); thus this cluster of buildings may be seen as consisting of two separate groups: one in the south, characterized by the presence of two large compounds of rectangular enclosure (F1 and F2; Fig. 11); and another in the north with densely distributed buildings of smaller size. Between these two groups is a void space of about 110 m wide

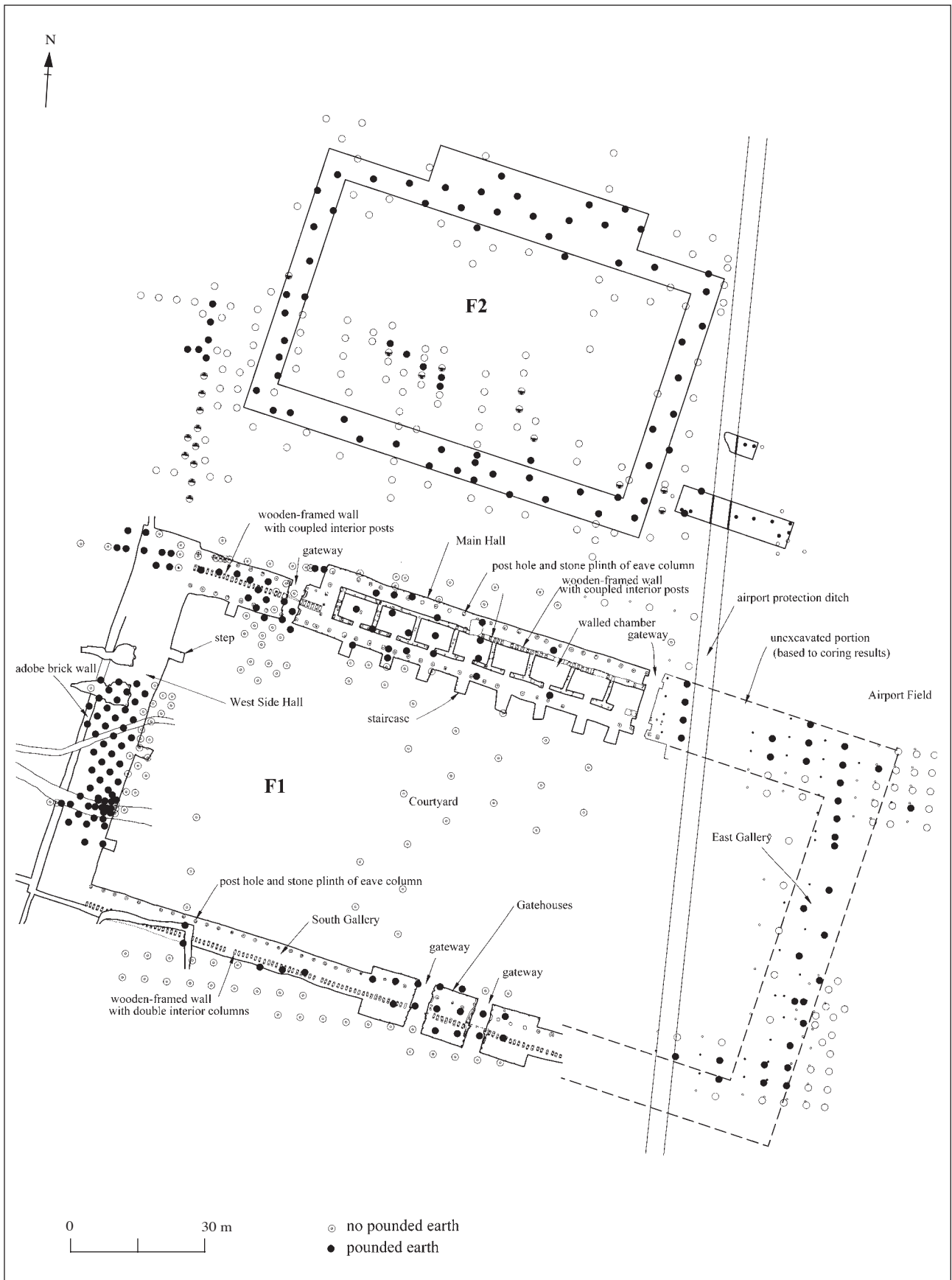

Fig. 11 Building compounds F1 and F2 detected through intensive coring
 The structure layout of F1 was exposed by later excavation (Zhongguo 2003)



Fig. 12 Photo of the cross-section of F1 along the ditch of section-cleaning

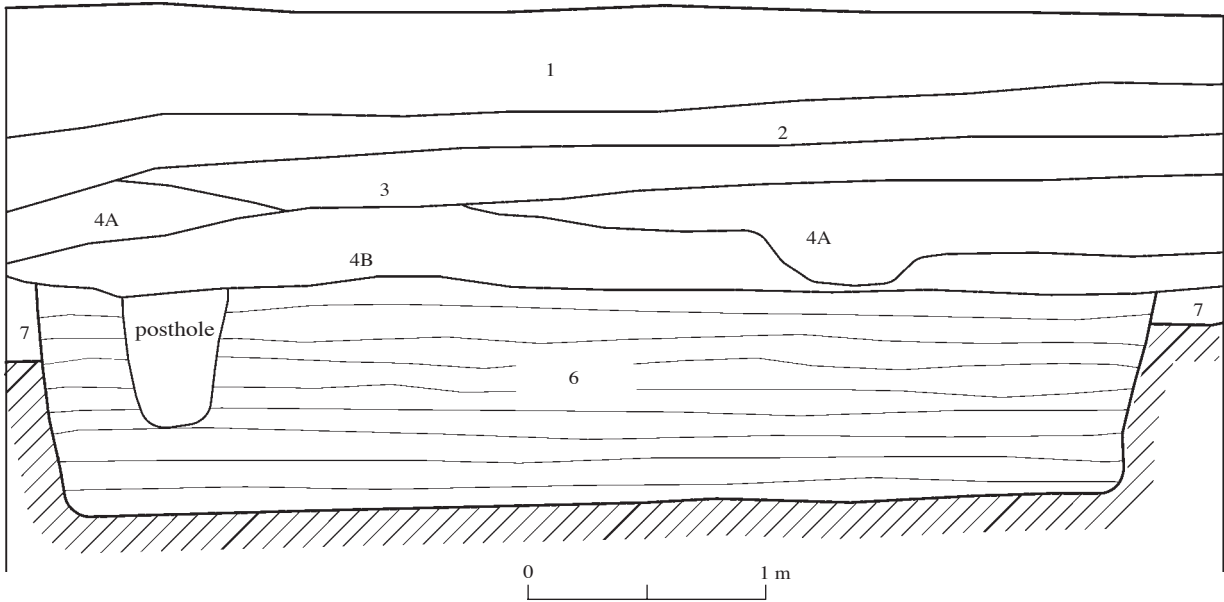

Fig. 13 Profile of the building remain F10 (Level 5 is not presented here)

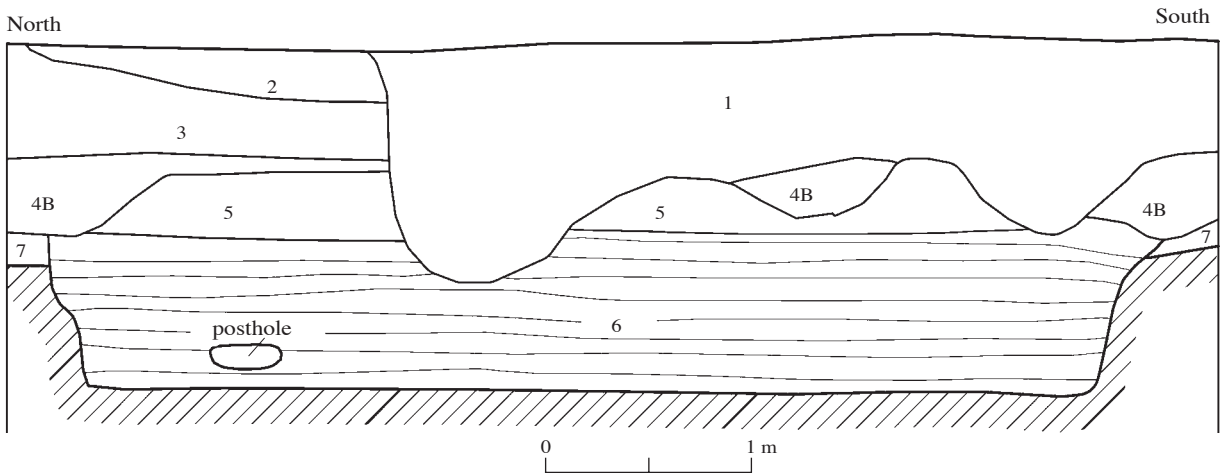

Fig. 14 Profile of the building remain F11 (Level 4A is not presented here)

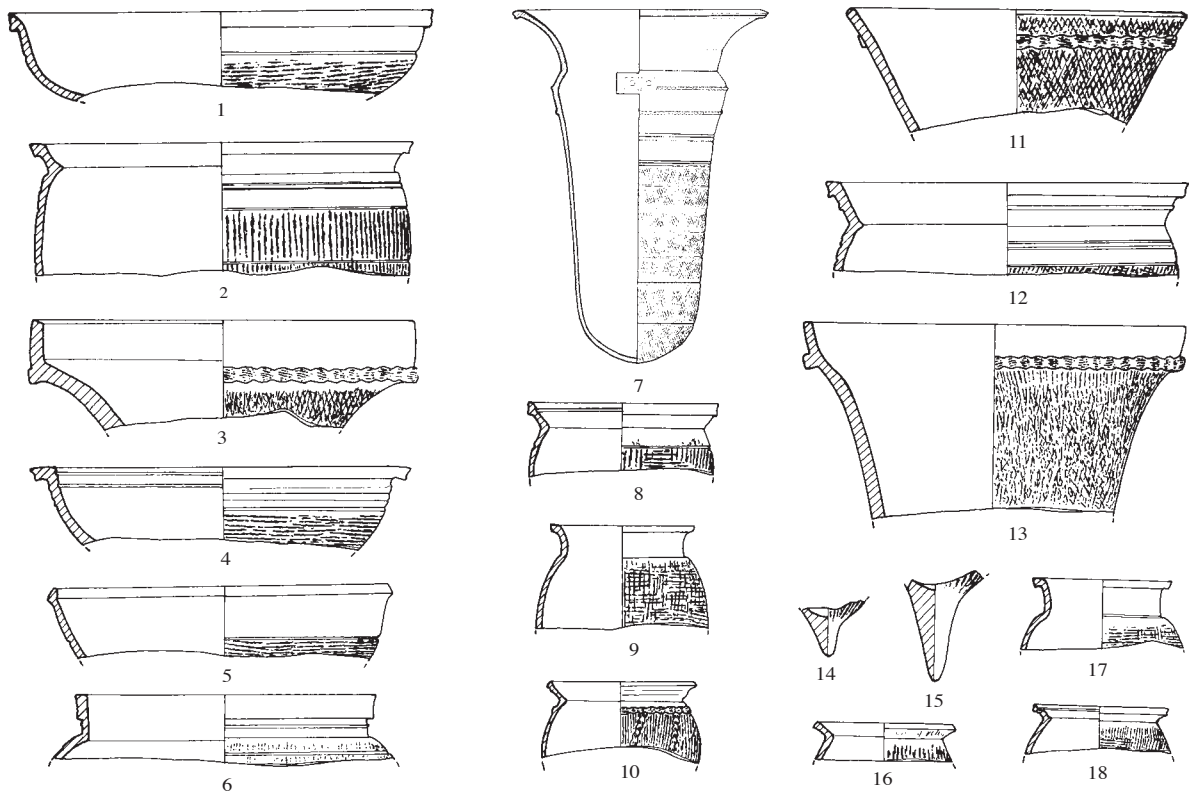

Fig. 15 Pottery samples from refuse pit H2

1, 4, 5. shallow bowls with rounded bottom (H2:11,18,10) 2, 12. deep bowls with flat bottom (H2:17, 14) 3, 11, 13. gang-vats (H2: 3, 1, 4) 6. weng-jar (H2:13) 7. large-mouthed zun-vessel (H2:7) 8, 10, 16, 18. li-tripods (H2:2, 6, 8, 5) 9, 17. guan-jars (H2:15, 16) 14, 15. li-tripod's feet (H2:9,12) (Scales: 7. 1/20; others 1/8)

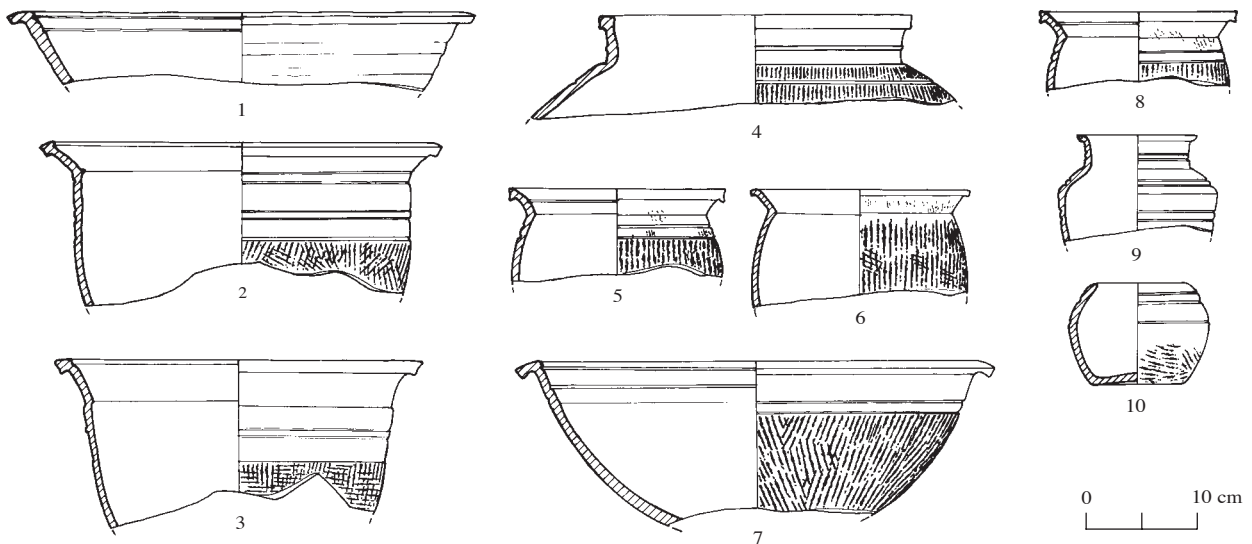

Fig. 16 Pottery samples from refuse pit H7

1, 7. shallow bowls with rounded bottom (H7:4, 3) 2, 3. deep bowls with flat bottom (H7:1, 6) 4, 9. guan-jars (H7:2, 5) 5, 6, 8. li-tripods (H7:10, 9, 7) 10. bo-bowl (H7:8)

where few remains except a relatively large refuse pit (H2) is found along the profile of section-cleaning. It is therefore very likely that these two groups of buildings might have served different functions.

The cross-section of F1²³ on the section-cleaning profile of the ditch shows that the remains of F1 platform foundation are composed of two parts, 0.9 m of dark brown pounded earth below the opening of the founda-

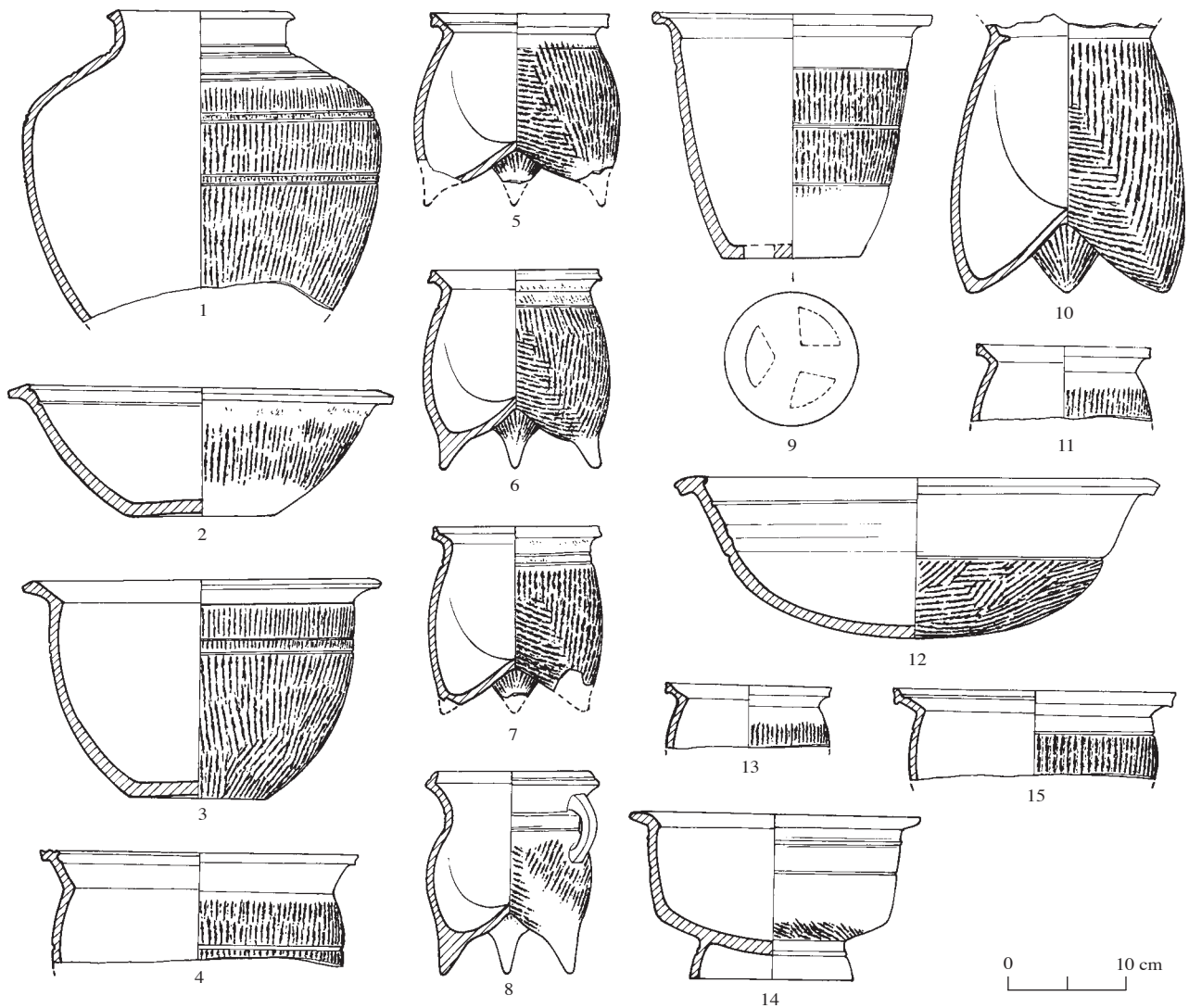

Fig. 17 Pottery samples from refuse pit H8

1. *weng*-jar (H8:15) 2. shallow bowl with flat bottom (H8:12) 3, 4, 15. deep bowls with flat bottom (H8:9, 4, 11) 5–7, 11, 13. *li*-tripods (H8:6, 3, 8, 10, 1) 8. *jia*-tripod (H8:5) 9. *zeng*-steamer (H8:13) 10. *yan*-steamer (H8:7) 12. shallow bowl with rounded bottom (H8:14) 14. *gui*-vessel (H8:2)

tion-trench, and 0.8 m of yellowish pounded earth above the foundation-trench that is about 15.8 m wide (Fig. 12). The pounding techniques as indicated by the thickness of each pounded layer as well as impressions and marks left by pounding appear no different for lower and upper parts of pounded earth²⁴. These pounded deposits were made by means of the use of small-wooden pestles that were bundled together. A sloped deposit of pounded earth was found on the south edge of the building platform, and this deposit represented one of staircases leading to the main hall, as confirmed by later excavation of the whole compound. Later excavation seems to suggest that the compound F1 might be “governmental or religious” rather than “residential” palace because of

very few remains associated with residential activities (Zhongguo 2003). Intensive coring of F2 also didn’t reveal much evidence of a residence²⁵. On the contrary, more residential waste deposits were detected around the buildings in the north that were densely but orderly placed, suggesting that they were likely residences of royalty, nobility, and others.

If both groups of buildings as a whole are believed to constitute part of so-called “palatial sector,” we may estimate or speculate the limit and size of “palatial sector.” The cluster of known buildings (including both groups in the south and north) measure about 550 m long north-south by 200 m wide east-west, with a total area of no less than 10 hectares. Based on the examination of

profiles in the 600 m ditch of section-cleaning and intensive coring, the buried road composed of compacted and foliated earth may represent the north limit of “palatial sector,” while the south limit may not be too far away from the south edge of F1. The east limit is to the west of the west airport runway. This building cluster is quite a bit off the central north-south axis of the walled area, and it is also out of proportion in terms of its length versus width. It is therefore very likely that the west limit of “palatial sector” may have certain distance from the west edge of F1. Given the potential symmetry of urban planning about the central axis of the city, the west limit of “palatial sector” may lie in Work Zones V-3 and VIII-1, and a conservative estimated area of the “palatial sector” would be no less than 20 hectares (see Fig. 2).

The soil material used for pounded earth buildings is very uniform and contains only a small number of ceramic artifacts, mostly of the Middle Shang. For the purpose of dating building remains, therefore, it becomes very critical to carefully study strata embracing these building remains, and other features within the same strata, particularly refuse pits that may yield a considerable number of dateable ceramic samples. More importantly, the analysis of the contextual data is very important in determining the function of these buildings as well as the nature of the area represented by them.

Seven stratigraphic levels (Figs. 13 and 14) can be identified on east profile of the section-cleaned ditch. A brief description of each level is as follows:

1: modern plowed or disturbed top soil, 0.3 m thick.

2: yellow or brownish yellow silt, 0.2–1.0 m thick; containing no cultural remains except some brick fragments of recent periods.

3: yellowish brown silt clay, 0.3–1.0 m thick, dated to the Warring States Period according to unearthened ceramics samples.

4: brown or yellowish brown silt clay, 0.2–0.4 m thick; containing Shang ceramic shards, and substantial amount of reddish burned earth and charcoal; including two sublevels 4A and 4B.

5: deposit of the platform above the foundation-trench, dark brown silt clay, or yellow or brownish yellow silt; 0.1–0.9 m thick; composed of layers of hard pounded earth; weathered in its upper part; not present in some buildings.

6: deposit of the foundation-trench, dark gray or dark brown clay or silt clay, 0.4–1.0 m thick; composed of layers of hard pounded earth, sometimes of slightly or not-pounded earth.

7: reddish brown soil, 0.2–0.3 m thick; containing a few Shang ceramic shards.

Beneath level 7 is dark brown or dark gray clay or silt clay (sterile soil, i.e. top A horizon of buried alluvial soil).

The foundation-trench portion of examined building remains is usually excavated into both level 7 and sterile soil; while the platform part of the building is overlain by level 4A or 4B, thus the dates of level 4 on the top and level 7 on the bottom should tell us when these buildings were constructed, used, and abandoned. Ceramic shards date level 4 to Phase III of the middle period²⁶. The refuse pits associated with these strata certainly provide the most reliable materials for relative dating. Like the remains of building platforms, all ten refuse pits of Shang period (H2–H11) found on the profile are superimposed by level 4, suggesting that these refuse pits might be in use during the same period as those buildings (see Fig. 9). Two of the refuse pits (H3 and H4) are symmetrically arranged between F9 and F10, and are likely associated with the use of these two buildings. A considerable amount of ceramics and other artifacts were unearthened from these refuse pits, and all identifiable ceramic shards are mostly dated to Phase II of the Middle Shang, and some to earlier periods including Longshan and Xiaqiyan 下七垣 phases (Figs. 15–17). Ceramic shards found in level 5 is also dated no later than the Middle Shang period. All these suggest that the buildings clustered in this part of the walled site might have been constructed and used during a short time no later than Phase II of the Middle Shang period.

Material finds are also an indication of the function and social status of built settlements in a stratified society. A preliminary artifact analysis suggests that pottery assemblages found in some refuse pits, particularly H2, are characterized by large size of vessels, particularly large-mouth *zun*-vessels 大口尊, bowls, jars, and *gui*-vessels 簋. Other forms of pottery vessels include *li*-tripods 鬲 and *jia*-vessels (see Fig. 15). An example is a *zun*-vessel found in the refuse pit H2, and it has a rounded base and large unrestricted orifice, measuring 0.85 m in height (Fig. 15:7). In terms of function and usage, serving vessels seem to dominate in pottery assemblages while the number of cooking and storage vessels is relatively small. All these may strongly suggest that many of these vessels were used for public activities instead of domestic needs. A piece of decorated white pottery was also found on the top of F24. In Late Shang societies, decorated white pottery was gifted in

the same way as bronze vessels so that they were usually found in a context of monumental architecture, such as in royal burials.

In short, the findings from coring and section-cleaning in the area covering Work Zones V-4 and VIII-2 were certainly products of high culture in the highly stratified society associated with the Huanbei Shang city, considerably different from those in other parts of the walled area that have been either surveyed or excavated. This area might be part of the palatial sector of the Huanbei Shang city.

References Cited

1. Blanton, R.E. (1976). "Anthropological Studies of Cities". *Annual Review of Anthropology* 5: 249–264.
2. Chang, K.C. (1976). *Early Chinese Civilization: Anthropological Perspectives*. Cambridge, Mass: Harvard University Press.
3. Dunnell, R. C. and Dancey W. S. (1983). "Siteless Survey: A Regional Scale Data Collection Strategy". In *Advances in Archaeological Method and Theory*, edited by M. B. Schiffer, pp. 267–287. vol. 6. Academic Press, New York.
4. Meng Xianwu 孟宪武(1985). "Anyang Sanjiazhuang faxian shangdai jiaocang qingtongqi 安阳三家庄发现商代窖藏青铜器". *Kaogu* 1985.12: 1139, 1140, and 1135.
5. Meng Xianwu (1991). "Anyang Sanjiazhuang Dongwangducun faxian de shangdai qingtongqi jiqi niandai tuding 安阳三家庄、董王度村发现的商代青铜器及其年代推定". *Kaogu* 1991.10: 932–938.
6. Tang Jigen 唐际根 (1999). "Zhongshang wenhua yanjiu 中商文化研究". *Kaogu Xuebao* 考古学报 1999. 4: 393–420.
7. Tang, G.J., Jing, Z.C. and Rapp, G. (2000). "The Largest Walled Shang City Located in Anyang, China". *Antiquity* 74 (285): 479–480.
8. Wheatley, P. (1971). *The Pivot of the Four Quarters: A Preliminary Enquiry into the Origins and Character of the Ancient Chinese City*. Edinburgh: Edinburgh University Press.
9. Yang Xizhang 杨锡璋(1989). "Yinren zun dongbei fangwei 殷人尊东北方位". In *Qingzhu Su Bingqi Kaogu Wushi Wu Nian Lunwenji* 庆祝苏秉琦考古五十五年论文集 pp. 305–314. Beijing: Wenwu Chubanshe 文物出版社.
10. Zhu Yanmin 朱彦民(2003). "Yinren zun dongbei fangwei shuo buzheng 殷人尊东北方位说补正". *Zhongyuan Wenwu* 中原文物 2003.6: 27–33.

11. Zhongguo Shehui Kexueyuan Kaogu Yanjiusuo, Meiguo Mingnisuda Daxue Keji Kaogu Shiyanshi Zhongmei Huanhe Liuyu Kaogudui 中国社会科学院考古研究所, 美国明尼苏达大学科技考古实验室中美洹河流域考古队(1998a). "Henan Anyang shi Huanbei Huayuanzhuang yizhi 1997 nian fajue jianbao 河南安阳市洹北花园庄遗址 1997 年发掘简报". *Kaogu* 考古 1998.10: 23–35.

12. Zhongguo Shehui Kexueyuan Kaogu Yanjiusuo Anyang Gongzuodui 中国社会科学院考古研究所安阳工作队 (1998b). "Huanhe liuyu quyu kaogu yanjiu chubu baogao 洹河流域区域考古研究初步报告". *Kaogu* 1998.10: 13–22.

13. Zhongguo Shehui Kexueyuan Kaogu Yanjiusuo Anyang Gongzuodui 中国社会科学院考古研究所安阳工作队(2003). "Henan Anyang shi Huanbei shangcheng gongdian qu yi hao jizhi fajue jianbao 河南安阳市洹北商城宫殿区 1 号基址发掘简报". *Kaogu* 2003.5: 17–23.

14. Zhongguo Shehui Kexueyuan Kaogu Yanjiusuo Anyang Gongzuodui 中国社会科学院考古研究所安阳工作队 (1983). "Henan Anyang Huanhe liuyue de kaogu diaocha 河南安阳洹河流域的考古调查". *Kaoguxue Jikan* 考古学集刊 1983.3: 90–97 and 108.

15. Zhongguo Shehui Kexueyuan Kaogu Yanjiusuo Anyang Gongzuodui 中国社会科学院考古研究所安阳工作队(2004). "1998 nian–1999 nian Anyang Huanbei shangcheng Huayuanzhuang dongdi fajue baogao 1998–1999 年安阳洹北商城花园庄东地发掘报告". *Kaoguxue Jikan* 2004.15: 296–358.

Endnotes

1. When the first survey work was conducted along the Huan River in early 1960s, the ceramic chronology available at that time was relatively coarse and some phases were poorly understood and inadequately or inaccurately represented, thus it did not allow the identification of the Middle Shang, the transitional period between Yin Xu phase of Late Shang and Zhengzhou phase of Early Shang. The materials collected in 1963 were actually identified as remains of Early Shang. As for the definition of the Middle Shang and its discussion, see Tang (1999).

2. Even though the extensive archaeological survey continued after 1997, the collaborative project gradually shifted its focus on the intensive survey at a number of selected sites and their surrounding areas. The rationale for this was the realization that extensive surface survey might not allow us to detail the site size, function, and

duration that were indispensable for the accurate reconstruction of settlement patterns over time, largely due to the inadequacy of surface samples in much of the study area.

3. In 1997 the Xia–Shang–Zhou Chronology Project was looking for a locality for excavation near Sanjiazhuang and Huayuanzhuang where the remains of so-called “early Phase I of the Yinxu period” were found, aiming at obtaining ^{14}C samples for the study of the chronology of Late Shang. The members from both the Xia–Shang–Zhou Chronology Project and the Sino-American joint project “Regional Archaeological Survey of the Huan River Valley” (often abbreviated as Anyang Project) visited the area near Sanjiazhuang and Huayuanzhuang, and located the deposit of “early Phase I of the Yinxu period” in a vegetable field west of Huayuanzhuang in the November of 1997 (see Locus 5 in Fig. 2). The subsequent excavation here indeed yielded important samples identified as of the period “between the Baijiazhuang Phase of Erligang Shang Culture and the Dasikongcun Phase I of Yinxu Shang Culture” for dating as expected (Zhongguo 1998a). Later analysis reassigned or relabeled those remains to the Huanbei phase of the Middle Shang (Tang 1999). The materials from the 1997 excavation also provided important information in our selection of the Huayuanzhuang area for intensive survey.

4. Both paleosols are most likely of early and middle Holocene in terms of their stratigraphic relation to cultural strata of different periods, ^{14}C dates, as well as regional loess sequences. The detailed discussion of these paleosols and their archaeological implications will be presented in other papers to be written by the same authors.

5. The subsequent intensive subsurface coring revealed that the Huanbei site is indeed positioned across two distinct geomorphic zones; the buried loess soil near the west wall is about 1.5–2 m deep, and the dark brown alluvial soil is buried to a depth of 2–3 m in the central and east part of the site. This has meaningful archaeological implications toward our interpretation of settlement patterns of Middle Shang and other periods. The floodplain lowland represented by the alluvial paleosol was most likely a stable surface, at least during a long time period prior to the Middle Shang occupation, which could sustain large settlements like the Huanbei Shang City. This certainly challenges the traditional assumption that human settlement always rested on the highlands. It is true that the visible remains on the surface today are

mostly limited to those high grounds. Such a presumption often leads to a biased description and explanation of settlement patterns in the past because it sees no impact of landscape changes on human settlement patterns.

6. The essential requirement of the regional archaeological survey is the collection of detailed information about the loci of past human activities. For a surface survey, the regional archaeological record is always seen as “a more or less continuous distribution of artifacts over the land surface with high density characteristics” (Dunnell and Dancy 1983). However, the regional archaeological record should also include cultural remains not visible on the land surface, especially those buried or obscured by sediments, vegetation, and later occupation. This is particularly the case in the regions with considerable sedimentation like the alluvial floodplain east of Anyang. When cultural remains are rarely visible on the ground, the surface collection would not produce enough and accurate data on the nature of surveyed sites/localities. Therefore, certain techniques for subsurface detection should be included in the survey program.

7. The results from this initial intensive survey directly led to the further excavations near Huayuanzhuang in the fall of 1998 and the spring of 1999, conducted by the Xia–Shang–Zhou Chronology Project. These excavations disclosed a number of house foundations, and obtained numerous pieces of pottery vessels, further confirming the date of buried cultural remains (Zhongguo 2004).

8. One additional trench was excavated across the east wall in the spring of 2001 before the full-scale field campaign began in the fall of 2001.

9. The paleosol on which early cultural remains rest is usually called *shengtū* 生土 (sterile soil) by archaeologists.

10. A large field immediately north of the apple orchard also grew vegetables densely, and it was accessible to us for a limited degree of drilling, but we didn't lay out a large numbers of cores because of the discovery of groups of pounded earth foundations soon after the survey work began in this area.

11. The west protection ditch of airport begins from its north end east of the village Hanwangdu and runs down to the south about 1000 m; and it is about 4 m wide and 2 m deep.

12. The profile of section cleaning runs from Work Quadrant V-2 in the north through V-4 to VIII-2 in the south.

13. Most building remains were found on both east and west profiles in the ditch, but some were seen only on one of two profiles. The labeling of buildings runs from south to north first based on their existence on the east profile, then those only exposed on the west profile were numbered from north to south. In addition, coring in the immediate area west of the ditch revealed at least five building foundations. Thus, a total of more than 30 buildings made of pounded earth were detected in the area near the airport protection ditch investigated in 2001.

14. The total area of the rectangular enclosure (F1) is about 15,660 sq m (174 m east-west by 90 m north-south). Since most of the courtyard was not excavated, the total excavated area is only half of the total area of the whole compound. About one third of the compound at its east end was not excavated because it was located within the field of the airport.

15. Buried cultural deposits of Middle Shang and other periods were found through intensive coring (in 2000) beyond each side of the walled area, particularly the neighboring region outside of the west wall. The actual size of the Huanbei site may be no less than 500–600 hectares. Yinxu measures some 1,700 hectares in area in terms of its conservation limit, and the actual size of habitation may not exceed 1,000 hectares. 2,400 or 3,000 hectares were often cited in literature because it included part of the Huanbei site on the one hand and the estimation was based on numbers in the extreme on the other hand.

16. The dark gray soil was most likely from the top A horizon of alluvial soil buried about 2 to 3 m below modern ground in east portion of the walled area at the Huanbei site.

17. In addition, the foundation-trench deposits in other sides of the wall contain relatively fragmentary animal bones. It remains uncertain whether these bones remains were associated with sacrificial events or domestic activities.

18. This piece of bored scapula is very similar to those found in the 1997–99 excavations east of Huayuanzhuang in the west part of the walled area (Zhongguo 1998a; Zhongguo 2004).

19. The coring work here was stopped by the Anyang

Pilot School because of a concern over the safety of airplane landing. As a consequence, we were unable to drill more cores determining the nature of this large feature.

20. It is possible that some individual buildings might belong to a single structure or a single compound although section-cleaning profiles along the ditch suggest that they are all separate from each other.

21. Because the profile along the ditch runs true north-south, cutting through the main axis (13 degrees of true east-west) of building foundations obliquely instead of perpendicularly, the actual width of buildings should be shorter than that measured on the profile. The widest foundation shown on the profile is F8 that measures about 19.5 m; but the coring reveals that its main axis is north-south instead of east-west. Its width in east-west is about 15 m.

22. The exact nature of the settlement abandonment at the Huanbei site remains elusive based on available data. It was also quite possible that the buildings were abandoned deliberately by setting a fire in order to locate the royal house to a new place.

23. Later excavation of F1 revealed that this cross section cut through east end of the main hall that was a main structure of F1 compound (Zhongguo 2003).

24. The lower part of dark brownish pounded earth was most likely made of the top A horizon soil of buried floodplain alluvium. However the source of yellowish rammed earth on the top remains unclear because our geoaerchaeological survey has suggested that yellowish silt deposits of pre-Shang periods occurred only in the west portion of the walled city and further west. The deliberate use of different soils for building construction shall be one of the topics that need to be addressed in the future, hopefully it will help understand processes of early city planning and development.

25. The excavation of F1 shows that the courtyard of F1 could be accessed from the north through two gateways, and the main hall could be accessed also from the north through stairs (Zhongguo 2003), suggesting that two rectangular enclosures (F1 and F2) most likely belonged to the same compound (see Fig. 8).

26. The periodizations of the Middle Shang see Tang 1999.

Note: The original report was published in *Kaogu* 2003.5: 3–16 with 16 figures and written by Tang Jigen, Jing Zhichun 荆志淳, Liu Zhongfu 刘忠伏, and Yue Zhanwei 岳占伟. The present version is prepared and English-translated by Jing Zhichun.